

This article was downloaded by:

On: 22 January 2011

Access details: *Access Details: Free Access*

Publisher *Taylor & Francis*

Informa Ltd Registered in England and Wales Registered Number: 1072954 Registered office: Mortimer House, 37-41 Mortimer Street, London W1T 3JH, UK



The Journal of Adhesion

Publication details, including instructions for authors and subscription information:

<http://www.informaworld.com/smpp/title~content=t713453635>

Morphology and Damage Mechanisms of the Transcrystalline Interphase in Polypropylene

A. Lustiger^a; C. N. Marzinsky^a; R. R. Mueller^a; H. D. Wagner^b

^a Exxon Research and Engineering, Annandale, NJ, USA ^b Department of Materials and Interfaces, Weizmann Institute of Science, Rehovot, Israel

To cite this Article Lustiger, A. , Marzinsky, C. N. , Mueller, R. R. and Wagner, H. D.(1995) 'Morphology and Damage Mechanisms of the Transcrystalline Interphase in Polypropylene', *The Journal of Adhesion*, 53: 1, 1 – 14

To link to this Article: DOI: 10.1080/00218469508014368

URL: <http://dx.doi.org/10.1080/00218469508014368>

PLEASE SCROLL DOWN FOR ARTICLE

Full terms and conditions of use: <http://www.informaworld.com/terms-and-conditions-of-access.pdf>

This article may be used for research, teaching and private study purposes. Any substantial or systematic reproduction, re-distribution, re-selling, loan or sub-licensing, systematic supply or distribution in any form to anyone is expressly forbidden.

The publisher does not give any warranty express or implied or make any representation that the contents will be complete or accurate or up to date. The accuracy of any instructions, formulae and drug doses should be independently verified with primary sources. The publisher shall not be liable for any loss, actions, claims, proceedings, demand or costs or damages whatsoever or howsoever caused arising directly or indirectly in connection with or arising out of the use of this material.

Morphology and Damage Mechanisms of the Transcrystalline Interphase in Polypropylene*

A. LUSTIGER, C. N. MARZINSKY, R. R. MUELLER and H. D. WAGNER**

Exxon Research and Engineering, Route 22 East, Annandale, NJ 08801, USA

(Received July 12, 1994; in final form October 13, 1994)

By coating glass fibers with the appropriate nucleating agent, transcrystallinity can be generated in polypropylene/glass composites. Transcrystallinity can consist either of the alpha (monoclinic) or beta (hexagonal) crystal structure. Through the use of directional solidification, the transcrystalline morphology can be duplicated in polypropylene films on a level large enough for mechanical and morphological study. Permanganic etching and subsequent electron microscopy reveals that lamellar orientation in alpha transcrystallinity differs significantly from the beta form. Alpha transcrystallinity consists of lamellae which are edge-on relative to the polypropylene film thickness, while beta transcrystallinity consists of lamellae which are primarily flat-on. This difference in morphology results in significant variations in mechanical properties and damage mechanisms.

KEY WORDS: transcrystallinity; polypropylene; lamellae; morphology; directional solidification; hexagonal; monoclinic

INTRODUCTION

The subject of transcrystallinity has been an area of enduring interest in the field of polymer composites, partly because the microscopic appearance of these columnar crystal growths is so dramatic. There is some controversy in the literature regarding whether or not transcrystallinity improves load transfer or toughness in polymer composites, and it is now becoming generally recognized that it is impossible to generalize regarding the effect of transcrystallinity on different polymer-fiber combinations.¹

An intriguing and previously unexplored avenue of investigation is the possibility of inducing transcrystallinity of a different crystal form than the surrounding matrix. It is well-known, for example, that isotactic polypropylene can crystallize in a number of crystal forms.² The most thermodynamically stable of these, the alpha (monoclinic) phase, is overwhelmingly the preferred form in melt crystallized polypropylene. Yet, if one adds the proper nucleating additive, the beta (hexagonal) form can be found in significant quantity in these materials as well.³ Taking this approach further, one could

* One of a Collection of papers honoring Lawrence T. Drzal, the recipient in February 1995 of The Adhesion Society Award for Excellence in Adhesion Science, Sponsored by 3M.

** Permanent address: Weizmann Institute of Science, Department of Materials and Interfaces, Rehovot, Israel.

introduce beta transcrystallinity in an alpha matrix by coating the reinforcing fibers with the appropriate nucleant.

The work herein reported presents some microscopic observations regarding the morphology and deformation associated with alpha and beta transcrystallinity. In order to facilitate these observations, directional solidification was introduced as a method to duplicate the transcrystalline interphase on a wider scale so the tensile properties of the transcrystalline region could be determined.

EXPERIMENTAL

Materials

The matrix used was a commercial (Exxon PD5052) isotactic polypropylene [MFI = 1.3], with $M_n = 88,700$ and $M_w = 360,000$. E-glass fibers were supplied by Owens Corning Fiberglass containing a proprietary sizing for better compatibility with polypropylene. These fibers, denoted as 157 C, have an average diameter of 16 microns, and were subsequently coated with a 1% solution of E3B quinacridone pigment (Hoechst Celanese) in dimethylformamide, which yielded the beta crystalline form.

Directional Solidification Apparatus

The principle and apparatus for directional solidification have been described by both Lovinger *et al.*^{4,5} and Huang *et al.*⁶ and our apparatus was modeled after these researchers. The polymer is sandwiched between two standard microscope slides and melted in a spring-loaded press under vacuum at 230 C. Specimens are pressed in a vacuum oven to assure a minimum of thickness variation in the specimen film and to reduce trapped air. After the slides are examined for thickness variations, they are placed on a temperature gradient apparatus as shown schematically in Figure 1. Lovinger *et al.*⁵ had demonstrated that through the use of directional solidification, both the alpha as well as the beta crystal forms could be readily induced without the need for special nucleating agents.

A minimal length of adhesive tape is used to attach the cold end of the slide to a standard medical industry infusion pump. The specimen is then placed in a nitrogen-purged environment and dragged slowly from a hot 500 F (260 C) surface to a cold 50 F (10 C) surface at varying rates depending on the tendency of the material to initiate spherulites and whether the alpha or beta crystal forms were desired. The distance

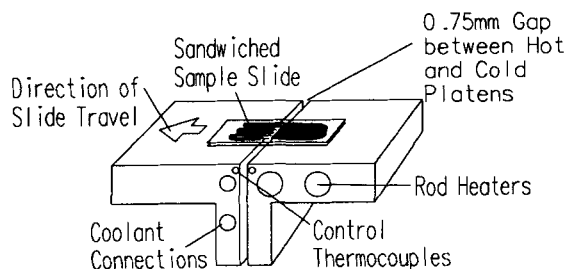

FIGURE 1 Schematic of temperature gradient apparatus for directional solidification.

between the hot and cold surfaces was 0.030 inches (0.76 mm) with great care taken to ensure that both surfaces were at the same height. Typical displacement rates, controlled by the infusion pump, were 5 to 50 microns/minute.

Because the films of directionally-solidified material were so fragile, they could not be peeled off from between the two glass slides. As a result, the films were removed by dissolving the glass slides in hydrofluoric acid.

Mechanical Testing

Samples were deformed on an Instron pulling at 0.05 inch/minute (1.27 mm/minute) both perpendicular and parallel to the solidification direction. These deformed samples, which contained both crystal forms, were observed under the SEM.

Fourier Transform Infrared (FTIR) Dichroism

FTIR dichroism was implemented on the directionally-solidified material to elaborate details of the molecular orientation in beta *versus* alpha transcrystallinity. A Nicolet spectrometer was used along with a wire grid polarizer for these measurements.

Scanning Electron Microscopy (SEM)

SEM of directionally-solidified samples was performed after etching using a potassium permanganate-sulfuric acid etching technique described by Bassett *et al.*⁷

Single Fiber Composite Tests

Tensile testing of SFC samples was performed using a custom-made mechanical test apparatus fitted to the stage of a Leitz microscope. The procedure of the test is similar to that of Wagner and co-authors.^{8,9} Using a hot plate, the samples were prepared by melting a previously-pressed polypropylene film on a microscope slide at 200C. A single fiber under slight tension was then carefully deposited on the molten film and a second microscope slide placed on top. This sandwich unit was then transferred to a hot press previously heated at 130C, and put under very slight pressure for about 10 minutes. The samples were then cut to size with a resulting gauge length of 40 mm and an approximate thickness of 0.2 mm. Tensile tests were performed at a speed of 500 mm/min.

RESULTS AND DISCUSSION

Damage Generation in Presence of Transcrystallinity

Several SFC tests were performed using identical samples. The number of fiber breaks obtained was very low relative to previously-reported results on, for example, epoxy-carbon fiber samples due to the much poorer fiber/matrix interface between glass and polypropylene. Even when the polypropylene matrix coupled with maleic anhydride was used to improve the interfacial bonding, an average of only 6 breaks over the 40 mm gauge length was observed until saturation was obtained.

Interestingly, even from the early stages of the test, damaged regions were observed to initiate at the fiber-matrix interface and to propagate across the transcrystalline

zone. The observed damage pattern was, however, different for the alpha *versus* the beta transcrystallinity.

Figure 2a is a polarized light micrograph of the damage pattern which forms around the fiber during the fragmentation test in alpha transcrystallinity. Under SEM (Figure 2b) an individual damaged region is shown to consist of an interlamellar crack within the transcrystalline zone, which subsequently propagates through spherulites in the matrix. We call this appearance “treeing”, since there is a marked microscopic resemblance

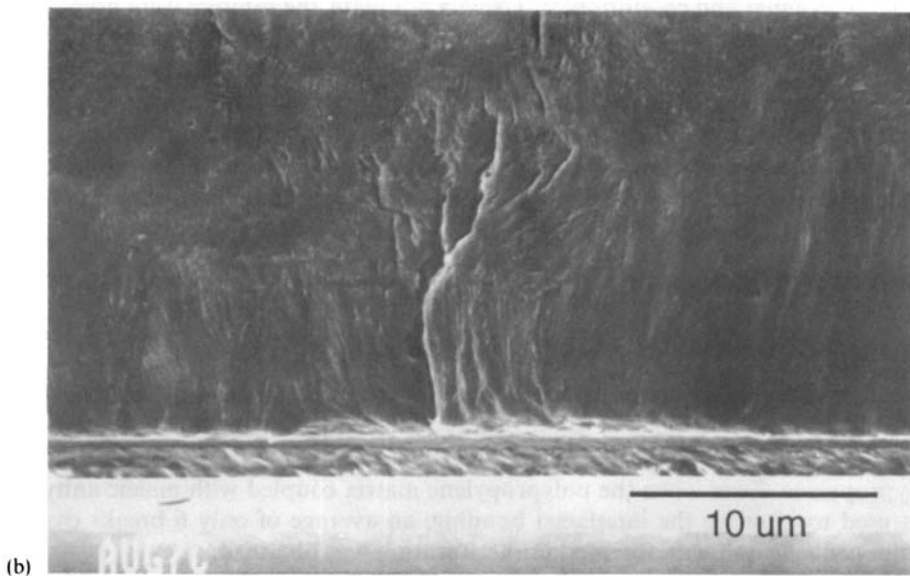
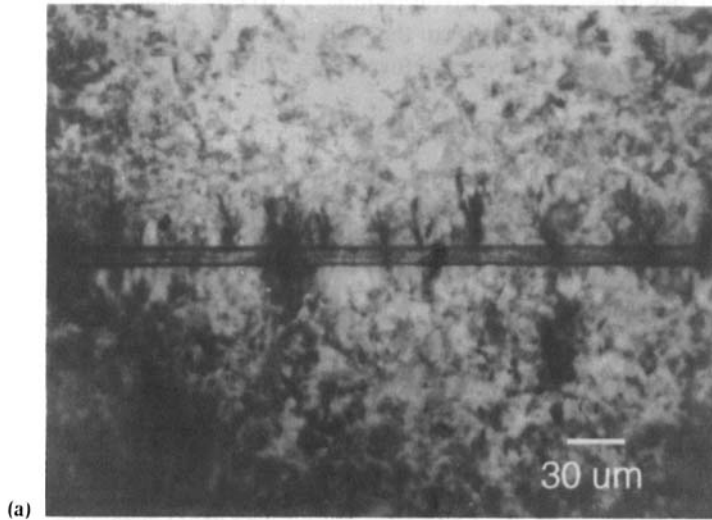

FIGURE 2 Optical (a) and electron microscope view (b) of treeing in alpha transcrystallinity.

to the so-called treeing phenomenon in dielectric materials, which in semi-crystalline cable insulation is also posited to be interlamellar in nature.¹⁰ Figure 3 is a polarized light micrograph of this “treeing” in the presence of beta transcrystallinity. It can be seen that the density of the tree appearance is higher in the beta transcrystalline region.

Directional Solidification

A low magnification optical microscopy view of directionally-solidified material in both the alpha and beta forms is shown in Figure 4. The beta material displays much greater birefringence and a 20–70% greater crystallization rate.⁵ As a result, once beta nucleation occurs, the beta region grows in a V-shape, overtaking the alpha material, until the entire specimen width is covered by beta material, with only incipient islands of tear-drop-shaped alpha spherulites initiating but inevitably overtaken by the beta material.

For the directionally-solidified samples as well as for the samples containing transcrystallinity, the alpha form lamellae were found to lay “edge-on”, *i.e.* with the lamellar surface perpendicular to the surface of the polypropylene films (Fig. 5). In contrast, the beta form lamellae were found to lay “flat-on”, *i.e.* with the lamellar surface parallel to the film surface (Fig. 6). The same features were evident within the alpha and beta transcrystalline regions in the single fiber specimens (Figs. 7 and 8, respectively). Because of the morphological similarity, it was felt that directional solidification provided a method for simulating transcrystallinity, but on a scale larger than a few microns. Through the use of directional solidification we could generate tensile data and perform analytical characterization on a composite interphase in ways that would otherwise be precluded were we limited to microcomposite samples.

Note the hexagonal features of the directionally solidified sample in Figure 6 as well as similar features in the beta transcrystallinity of Figure 8. These are presumably etch

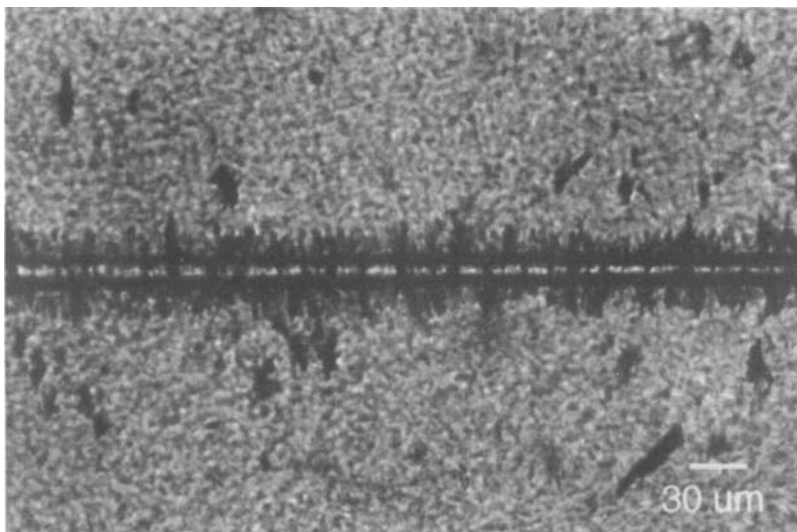

FIGURE 3 Optical micrograph of treeing in beta transcrystallinity.

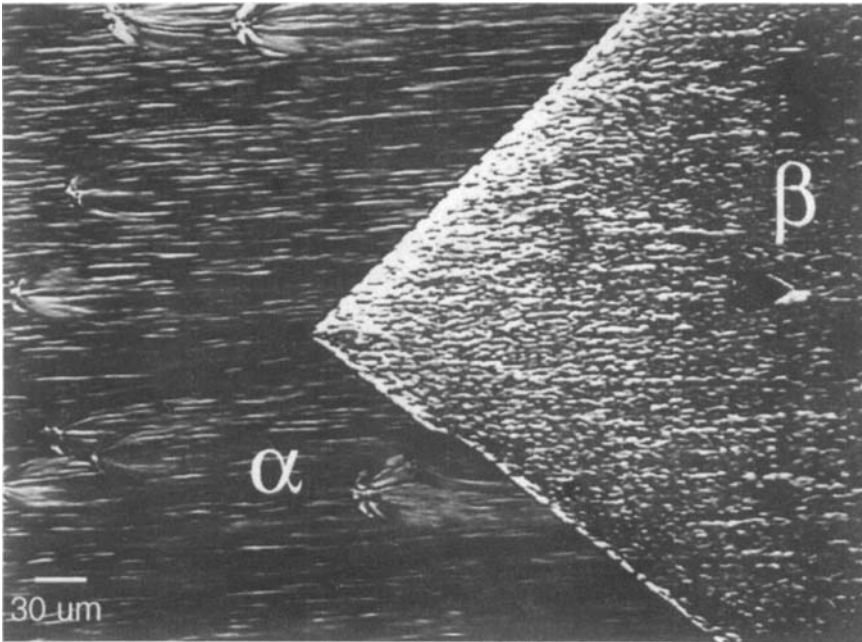

FIGURE 4 Optical microscope view of directionally-solidified polypropylene: showing alpha and beta regions.

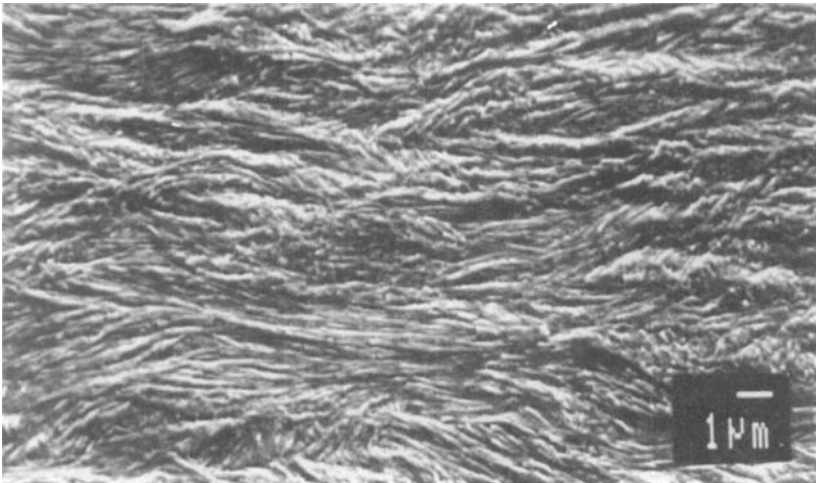

FIGURE 5 SEM view of edge-on alpha lamellae.

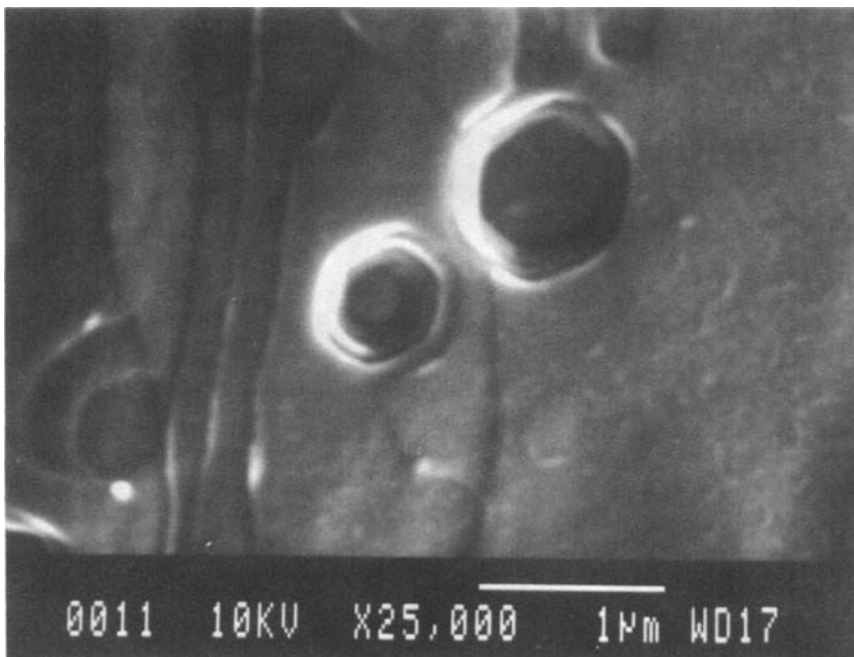

FIGURE 6 SEM view of flat-on beta lamellae. Note hexagonal etch pits.

pits resulting from the permanganic etching, which apparently reflects the hexagonal unit cell of the beta form of polypropylene. This appearance, in turn, suggests that the hexagonal basal plane is parallel to the lamellar surface.

To verify this suggestion regarding the orientation of the hexagonal basal plane, x-ray texture studies were implemented on this material. Using the Miller Index notation, the basal plane corresponds to the $\{0001\}$ family of planes. Unfortunately, this plane showed a very weak reflection in the x-ray scan. Instead, the $\{10\bar{1}0\}$ plane family was interrogated, corresponding to the six unit-cell faces perpendicular to the basal plane. If our supposition is correct that the hexagonal basal plane is parallel to the lamellar surface, then these six unit-cell faces in this orientation would be perpendicular to the lamellar surface, and would be expected to display six lobes towards the outer ends in the pole figure. In fact, Figure 9 does show these six lobes. However, in addition, the pole figure indicates that there is a somewhat smaller population of $\{10\bar{1}0\}$ planes oriented parallel to the lamellar surface plane as well. This result either suggests that there are two lamellae populations with differing orientation, a result not evident through electron microscopy, or that there are two populations of crystal orientation within the flat-on lamellae themselves.

Tensile data on beta directionally-solidified samples both parallel and perpendicular to the growth direction are shown in Figure 10. Accurate tensile data could not be generated in the alpha case, as the alpha material was found to be very brittle. This brittleness resulted in premature failure that initiated from bulk or edge defects during

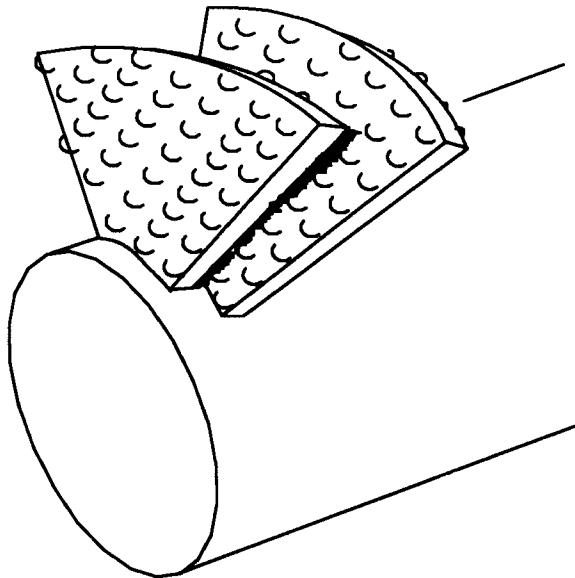
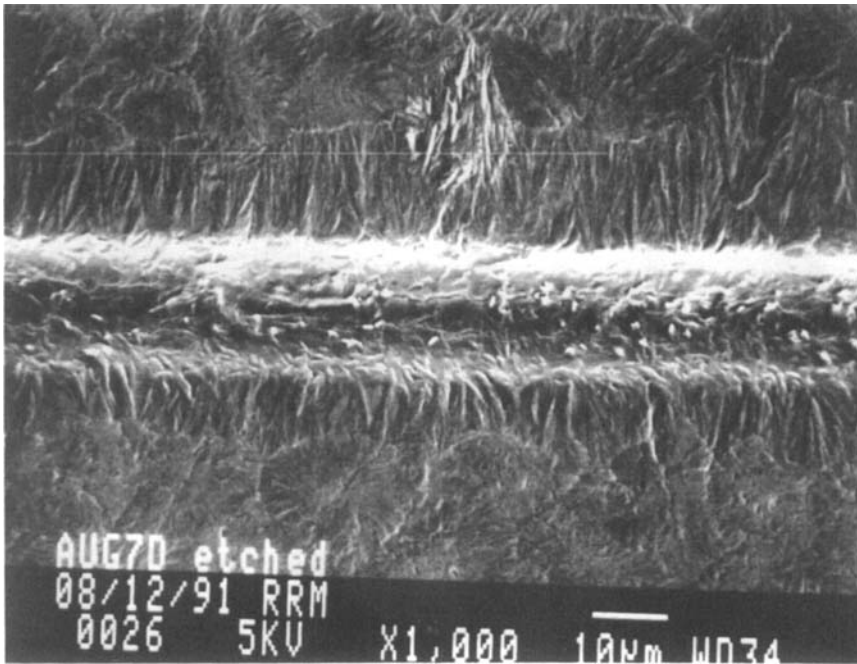

FIGURE 7 SEM view of alpha transcrystallinity from glass fiber and accompanying schematic showing edge-on lamellae. Note overall similarity to Figure 5.

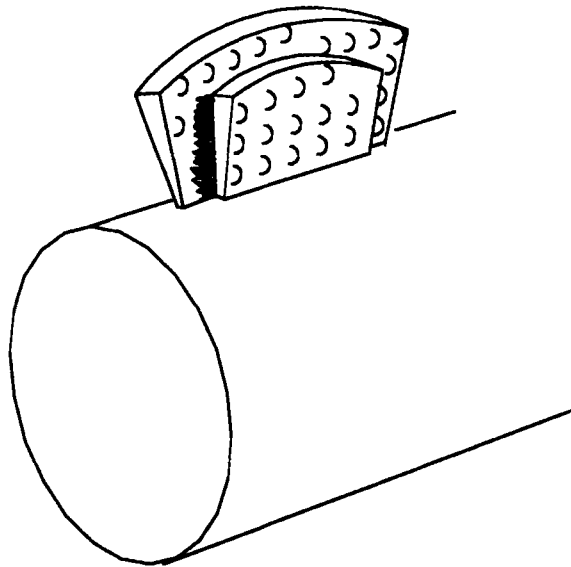
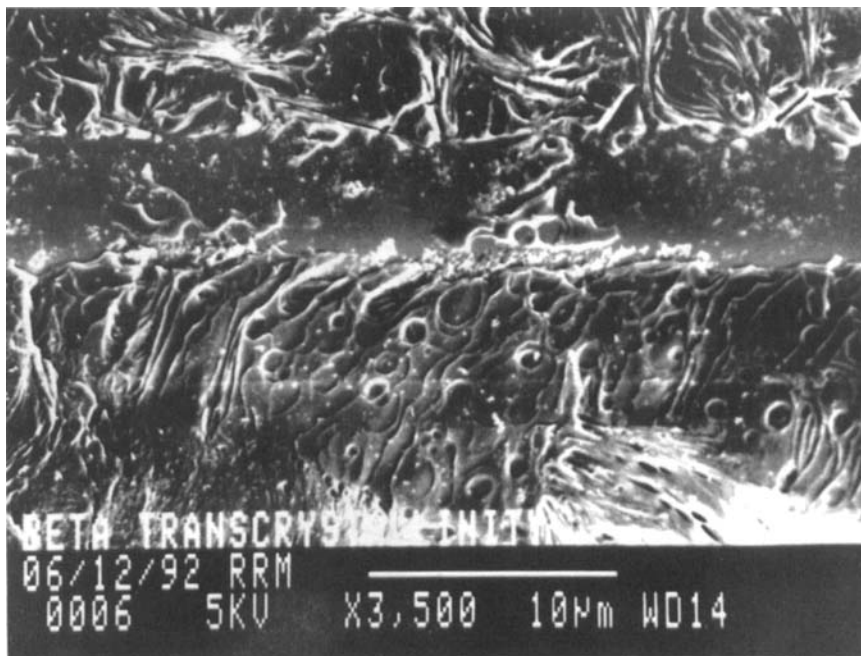

FIGURE 8 SEM view of beta transcrystallinity from glass fiber and accompanying schematic showing flat-on lamellae. Note overall similarity to Figure 6, including hexagonal etch pit formation.

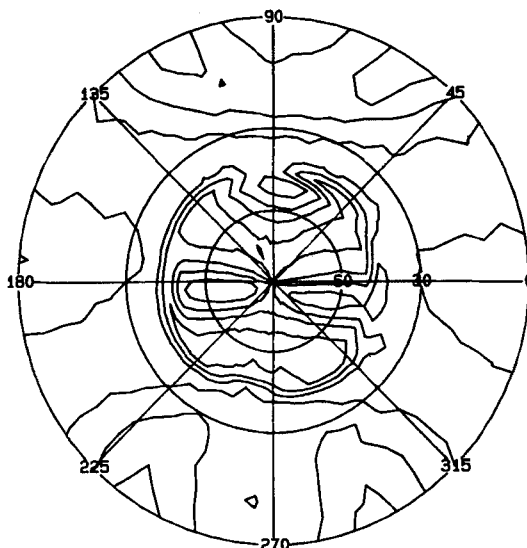

FIGURE 9 Pole Figure of $\{10\bar{1}0\}$ hexagonal plane in directionally-solidified beta PP.

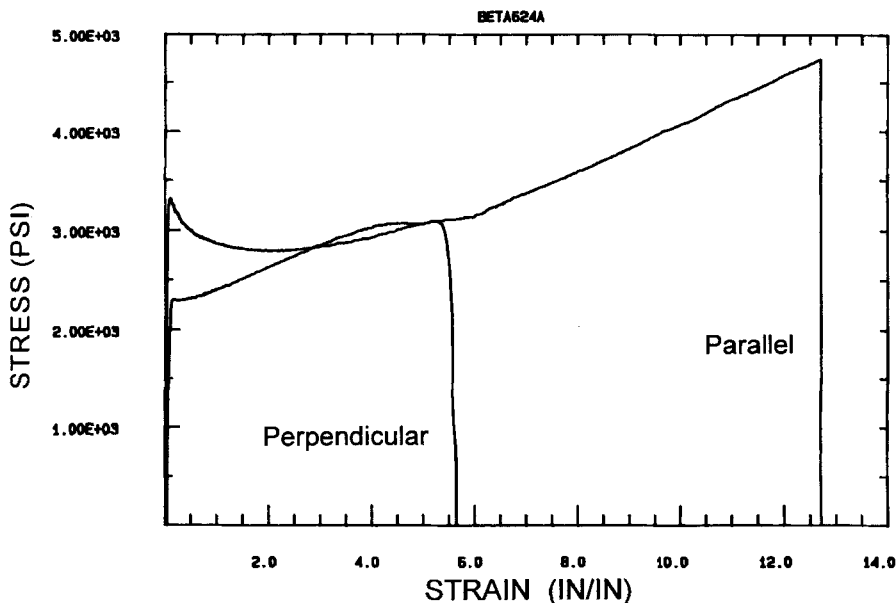

FIGURE 10 Tensile data on directionally-solidified beta PP both perpendicular and parallel to lamellar growth direction.

tensile testing. In beta polypropylene, our tensile measurements revealed definite anisotropy parallel and perpendicular to the solidification direction. This feature was somewhat surprising, since the appearance of flat-on lamellae would suggest isotropy within the plane of the polymer film. Yet, the infrared dichroism confirms that there is,

indeed, significant structural anisotropy in the beta (Figure 11) as well as in the alpha directionally-solidified samples.

These data can be understood by considering that the X-ray pole figure data indicated the presence of a population of basal planes perpendicular to the lamellar

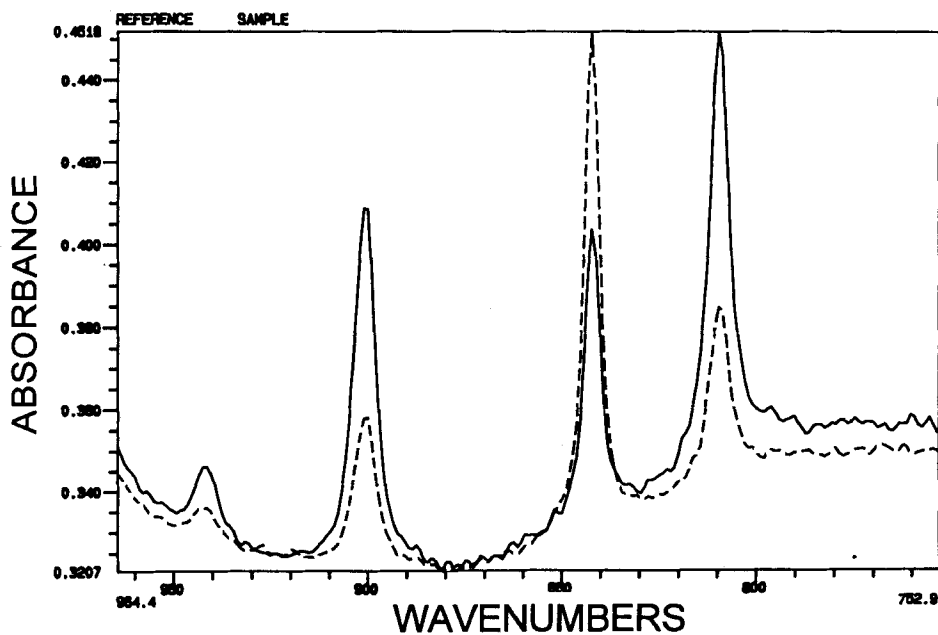

FIGURE 11 Infrared dichroism in directionally-solidified beta PP. Dotted line-perpendicular polarization. Solid line-parallel polarization.

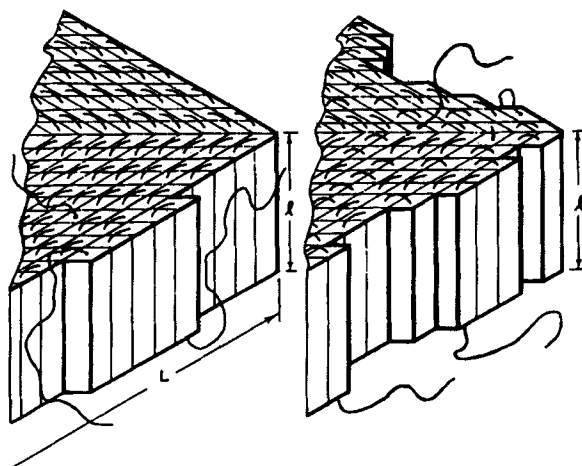

FIGURE 12 Regime 1 versus Regime 2 crystallization, illustrating inherent anisotropy of lamellar surface in Regime 1 (from Ref. 11).

surface, suggesting the presence of some lamellae not lying flat-on. In addition, as an added factor, it should be noted that the slow crystal growth rates in our directional solidification experiments are almost certainly within Regime 1 crystallization kinetics¹¹ (Figure 12). Lamellar layers in the growth direction rapidly grow laterally and are completed before new nuclei are formed in succeeding layers. Lamellae grown in this way could be inherently anisotropic when comparing the growth direction with the lateral direction.

A tensile sample containing both directionally-solidified alpha and beta material was pulled on the Instron. A low magnification SEM view of the sample is shown in Figure 13. A crack can be seen initiating in the alpha region and propagating until the beta boundary, a phenomenon which was not unexpected given the brittle nature of the alpha material. A higher magnification view of the boundary between the alpha and beta material shows that the beta material displayed uniformly-distributed crazes (Figure 14). In contrast, crazing in the alpha region was more localized, limited to the vicinity of the crack. As a result, the beta material displays higher toughness. Apparently, the metastable beta crystal form can absorb more energy than the alpha form, yielding the uniform intralamellar craze deformation that stopped the alpha crack from propagating into the beta region.

The nature of the craze deformation in the directionally-solidified samples is apparently similar to the treeing phenomenon in the single fiber composite specimens

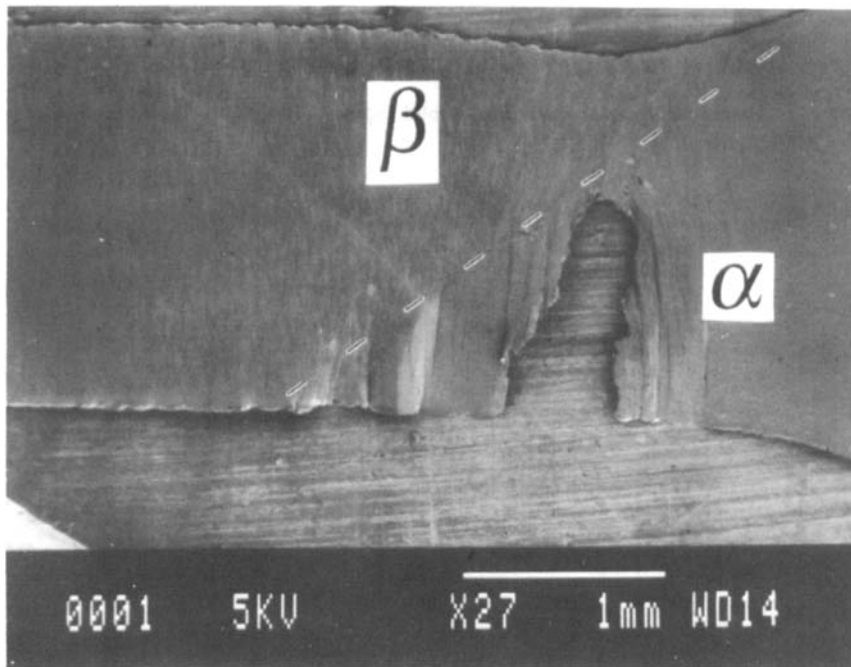

FIGURE 13 Directionally-solidified film after tensile testing, showing alpha and beta regions. Note crack in alpha region arrested at beta boundary.

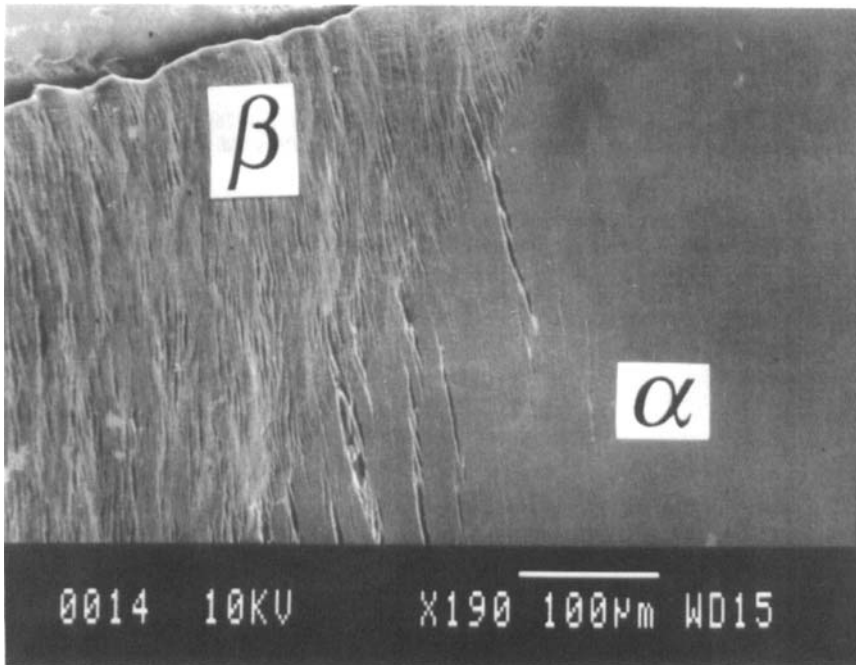

FIGURE 14 Higher magnification view of Figure 13 at alpha-beta boundary, showing uniform craze deformation in beta region.

on a larger scale, since, as shown above, beta transcrystallinity displayed a more uniform population of "trees" than in the alpha form (Figures 2a and 3).

CONCLUSIONS

Through the use of directional solidification, morphological aspects of both alpha and beta transcrystallinity in isotactic polypropylene can be elucidated. Lamellae are edge-on in alpha transcrystallinity, while they are primarily flat-on in beta. Anisotropy in mechanical properties of directionally-solidified samples in the beta form can be confirmed structurally through infrared dichroism measurements. The anisotropy can, in turn, be rationalized using a crystallization kinetics argument. The beta form is significantly tougher than the alpha form due to its propensity for uniform intralamellar deformation accompanied by crazing.

Acknowledgements

The authors wish to thank Andy Lovinger of AT&T Bell Laboratories for use of his directional solidification apparatus and discussions which guided our design of similar equipment. We would also like to thank Doug Keith at the University of Connecticut for his careful review and most helpful criticism of this manuscript.

References

1. A. Lustiger, *Polymer Composites* **13**, 408 (1992).
2. H. D. Keith, F. J. Padden, N. M. Walter and H. W. Wyckoff, *J. Appl. Phys.* **30**, 1485 (1959).
3. H. J. Leugering, *Makromolekulare Chemie*, **109**, 204 (1967).
4. A. J. Lovinger, O. Chua and C. C. Gryte, *J. Physics, Part E* **11**, 927 (1976).
5. A. J. Lovinger, O. Chua and C. C. Gryte, *J. Polym. Sci., Polym. Phys. Ed.* **15**, 641 (1977).
6. Y. Huang and J. Petermann, *Polymer Bulletin* **24**, 2980 (1991).
7. D. C. Bassett and R. H. Olley, *Polymer* **25**, 935 (1984).
8. H. D. Wagner and L. W. Steenbakkens, *J. Mater. Sci.* **24**, 3956 (1989).
9. B. Yavin, H. E. Gallis, J. Scherf, A. Eitan and H. D. Wagner, *Polymer Composites* **12**, 36 (1991).
10. Y. Poggi, V. Rahamalala and J. C. Filipini, *Polymer* **32**, 2980 (1991).
11. J. D. Hoffman, G. T. Davis and J. I. Lauritzen, Jr., Chapter 7 in *Treatise on Solid State Chemistry, Vol. 3, Crystalline and Noncrystalline Solids*, N. B. Hannay, Ed. (Plenum, New York, 1976), pp. 497–614.